

FL203M-3E (B47)

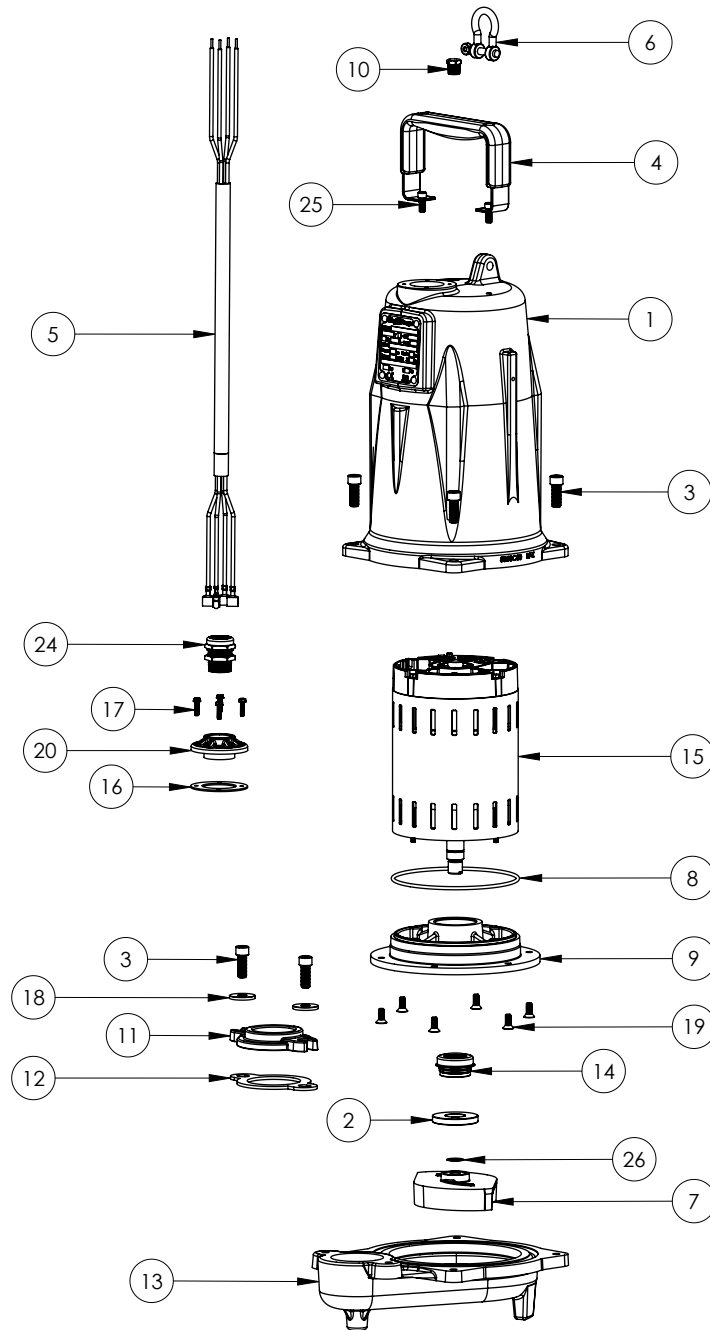

FL203M-3E (B47)

#	PART #	DESCRIPTION	QTY	Note
1	585000R	MOTOR COVER PAINTED	1	
2	5618000	DOUBLE LIP SEAL	1	[1]
3	5862000	BOLT, 3/8-16X1 SHCS SS	6	
4	5613000	HANDLE	1	
5	K001419	IEC 3PH 10M CORD KIT	1	
6	5611000	SHACKLE	1	
7	5853000	IMPELLER	1	
8	5617000	O-RING	1	
9	5851000	MOTOR PLATE	1	
10	5071000	BRASS OIL PLUG	1	
11	K001421	1.5" DISCHARGE ADAPTER, INCLUDES HARDWARE AND GASKET	1	
12	5858000	1.5" FLANGE GASKET	1	
13	585400R	VOLUTE	1	
14	5633000	3/4" UNITIZED SHAFT SEAL	1	[1]
15	5859000	MOTOR, 3PHASE	1	[1]
16	5060000	CORD PLATE GASKET	1	
17	8064000	#8-32 x 5/8 HEX WASHER HEAD SCREW	4	
18	8158000	WASHER, 3/8 x 1-1/8, SS	2	
19	8018000	1/4-20 x 5/8 SLOTTED FLAT HEAD BOLT	6	
20	57890AR	PAINTED 3/4 NPT, CE CORD PLATE	1	
24	5790000	STRAIN RELIEF, 3/4 NPT STAINLESS, IEC	1	
25	8103000	SCREW 1/4-20x5/8" HX SKT SS	2	
26	5848000	SHIM WASHER .005" x 1/2"	1	

PART NOTES:

[1] - Part requires factory authorized service. Contact Liberty Pumps at 1-800-543-2550