

FL74M-2 (B78)

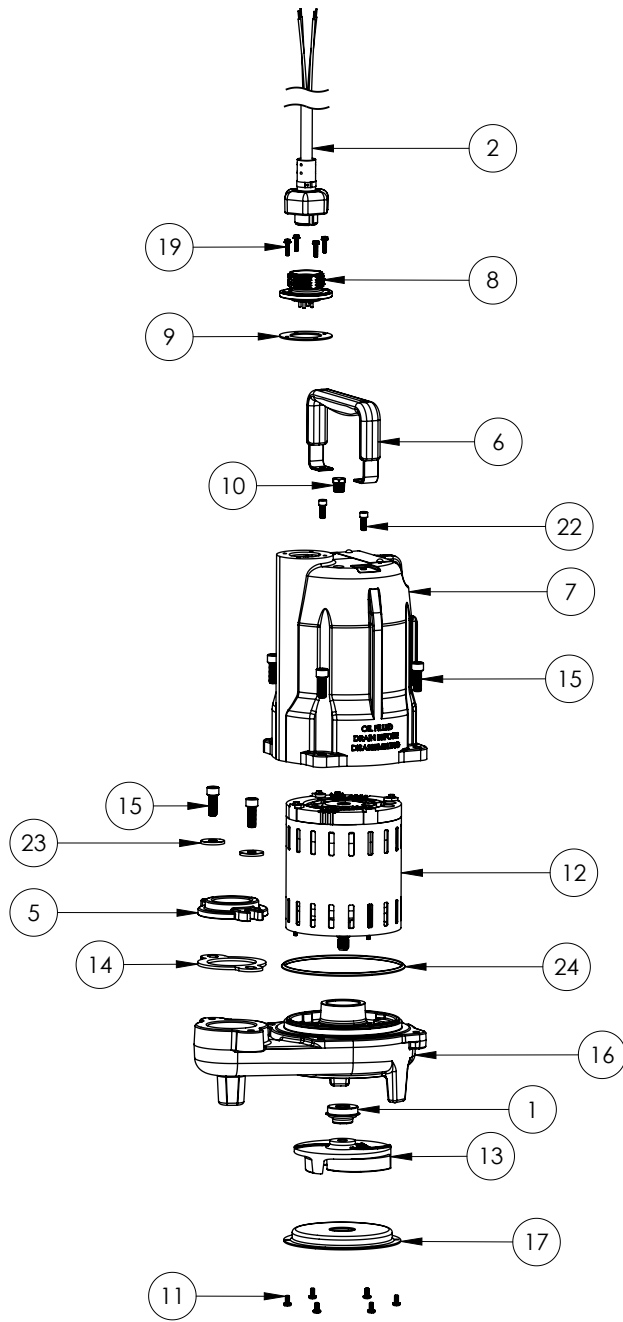

FL74M-2**FL74M-2 (B78)**

#	PART #	DESCRIPTION	QTY	Note
1	5120000	5/8 INCH UNITIZED SHAFT SEAL	1	[1]
2	K001357	POWER CORD, 25FT	1	
3	51960B0	CAPACITOR, 30uF	1	
5	586100R	1.5" ADAPTER FLANGE	1	
6	3411200	HANDLE	1	
7	340000R	MOTOR HOUSING, POWDER COATED	1	
8	5014000	CORD PLATE	1	
9	5060000	CORD PLATE GASKET	1	
10	50710A0	PIPE PLUG, 1/4" HEX HD BRASS NPTF	1	
11	8092000	#10 - 24 x 3/8" SCREW	6	
12	5367000	MOTOR 230V 1PH	1	
13	58340B0	IMPELLER	1	
14	5858000	1.5" FLANGE GASKET	1	
15	5862000	BOLT, 3/8-16X1 SHCS SS	6	
16	5889000	VOLUTE	1	
17	5891000	INLET STAMPING	1	
19	8064000	#8-32 x 5/8 HEX WASHER HEAD SCREW	4	
22	8103000	SCREW 1/4-20x5/8" HX SKT SS	2	
23	8158000	WASHER, 3/8 x 1-1/8, SS	2	
24	3403000	O-RING	1	

PART NOTES:

[1] - Part requires factory authorized service. Contact Liberty Pumps at 1-800-543-2550